

Installation and operating instruction

Charging station electrify eSat
for electric & hybrid vehicles

Type: r20

Version: 01.2021





hesotec electrify gmbh
Rubbertskaath 34
46539 Dinslaken / GER

HR - Nr. HRB 31112 AG Duisburg
St. - Nr. 101 / 5707 / 2333
UID - Nr. DE320783037

Phone +49(0) 2064 / 60 105 - 60
Fax +49(0) 2064 / 60 105 - 50

Web electrify.hesotec.de
Mail electrify@hesotec.de

Contents

1	Important Information and safety instructions.....	1
1.1	Foreword	1
1.2	General safety instructions	1
1.3	Safety instructions in this manual.....	2
2	Product overview and dimensions.....	3
2.1	Type plate	3
2.2	Charging Station	3
2.3	Foundation Frame Art. 00010033	4
2.4	Technical Data.....	5
3	Installation	7
3.1	Demands on Location of Charging Stations Location	7
3.2	Creation of the Charging Stations Foundation	8
3.3	Assembly of Charging Station.....	9
3.3.1	Assembly with Montage with Foundation Frame	9
3.3.2	Assembly on an alternative Ground	10
3.4	Electrical Installation	12
3.4.1	Electrical Installation of the Charging Station.....	13
3.4.2	Connection of the digital inputs.....	14
4	Operation	15
4.1	Control Element.....	15
4.2	LED indicator.....	15
4.3	Charging Process	17
4.3.1	Charging station without authorization (Plug & Start)	17
4.3.2	Charging station with RFID authorization	18
4.3.3	Charging Station with App Authorization (electrify Control Center) ...	19
5	Troubleshooting	20
5.1	Troubleshooting.....	20
5.2	Repair work	21
6	Maintenance / Disposal	22
6.1	Maintenance.....	22
6.2	Disposal	22
7	Appendix	23
7.1	CE-Label and Declaration of Conformity	23
8	Notes	24

1 Important Information and safety instructions

1.1 Foreword

We are pleased that you have chosen the electrify eSat charging station of hesotec electrify. With hesotec electrify, e-mobility is no longer a dream of the future but a reality.

With the electrify eSat you invest in an innovative technology, connected with a sophisticated design and robust compactness. Thanks to the modular and scalable design, it is not only possible to stylishly load on your own doorstep. It is also possible to offer individual complete solutions for companies. The charging unit complies with all existing safety guidelines and standards.

Read this installation and operating instructions completely before you start with the installation and commissioning. Keep this manual for future reference.

1.2 General safety instructions

To ensure proper installation and safe operation, follow the safety instructions given in this manual. Improper handling or non-compliance with the safety instructions may result in damage to the device itself, serious injury, fire or death. It is also advisable to ensure that every user of the charging unit has access to content-related aspects about operation and in particular to safety instructions.

The installation, commissioning and maintenance of the electrify eSat may only be carried out by a qualified electrician. The operation of the loading unit may only be carried out after a technically perfect installation with subsequent acceptance. Faults and repairs that lead to damage to persons, to the device itself or other consumers may only be carried out by qualified specialist personnel.

In case of malfunctions and malfunctions due to a faulty installation, first contact the company that carried out the installation. If the problem persists, contact the hesotec electrify hotline.

Phone +49(0) 2064 / 60 105 – 60

Mail electrify@hesotec.de



hesotec electrify assumes no liability for the following cases in the event of personal injury or property damage:

- Disregard of the installation and operating instructions
- Installation of unqualified technical personnel
- Structural alterations to the charging station
- Configuration changes of the charge controller
- Improper handling
- Use of unauthorized spare parts or accessories

1.3 Safety instructions in this manual

This manual contains essential information for the installation and commissioning of the eSat charging station of hesotec electrify. The following safety instructions are essential to be read and followed.

The warnings contained in this installation and operating manual must be observed with great care. The meaning of the individual markings is described below:

Mark	Meaning
	<p>DANGER !</p> <p>Safety note on a hazard with electrical voltage</p> <p>Non-observance of the instructions may result in electrical damage to the device itself, serious injury, and death.</p>
	<p>ATTENTION !</p> <p>Safety information on a hazard</p> <p>Non-observance of the instructions may result in damage to the device itself or other consumers. Execution with special care!</p>
	<p>NOTE !</p> <p>Important information and special features</p> <p>For a successful operation, the instructions should be carried out as needed.</p>

2 Product overview and dimensions

In this chapter you will get an overview of product information with the necessary dimensions for the optimal planning and preparation.

2.1 Type plate



Information on the type plate

- Manufacturer
- Series
- Model
- Power
- Serial number
- Manufacturing date
- Rated current
- Nominal voltage
- Nominal frequency
- Power supply
- Protection class

2.2 Charging Station

The purchased electrify eSat is already fully assembled and delivered after successful quality control. It is only a secured supply line between the house sub-distribution and the charging station needed. The respective requirements for the power connection can be found in the technical data.

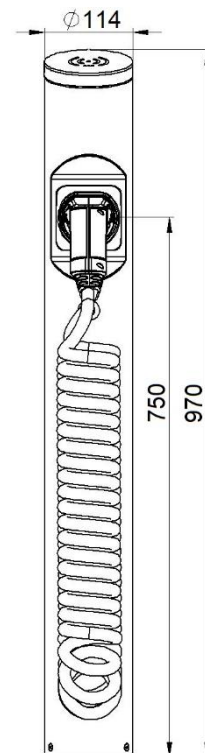

electrify eSat r20 charging station, left: 3D model; right: dimensions (measuring unit mm)

2.3 Foundation Frame Art. 00010033

For the creation of the ground foundation for safe and stable attachment of the charging station, hesotec electrify recommend the included foundation frame, which is poured in with concrete. With the help of prefabricated bolting points the assembly of the charging column is facilitated. The height can be adjusted on request.

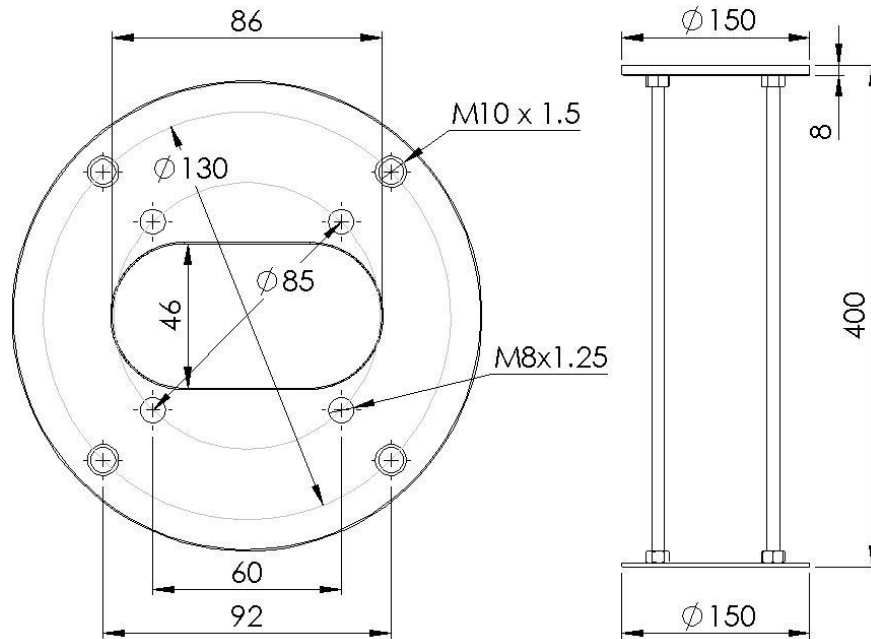

Top and side view of foundation frame (measuring unit mm)

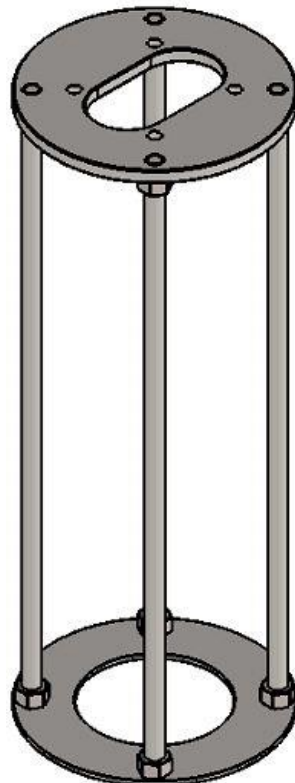

Three-dimensional view of foundation frame

2.4 Technical Data

eSat r20 Base 11kW / 22kW

Vehicle connection (output)	
1 x Charging plug Typ 2 with spiral cable	20 A* / 32 A, length about 4 m
Output voltage	230 / 400 V
Maximum charging current	16 A* / 32 A
Maximum charging power	11 kW* / 22 kW
Shutdown	All poles
Components	
DC fault current detection	electronic, $I_{\Delta n}$ d.c. ≥ 6 mA
Load contactor	4-pole with contact monitoring
Protection class	IP54
Communication	
Interface	WLAN, Digital Input
Protocol	eCCP, Modbus TCP
Authorization	APP, RFID, Plug & Start
Requirement power connection	
Mains connection	5 x 4 mm ² * / 5 x 6 mm ²
Rated voltage	230 / 400 V
Rated current	16 A* / 32 A
Safeguarding	20 A* / 32 A, 3-poles, B-characteristics
AC fault current detection	RCCB, Type A, 30mA
Dimensions	
Height	970 mm
Diameter	114 mm
Parkbox (height / center)	750 mm

*) Technical data for a maximum charging power of 11 kW

eSat r20 Smart 11kW / 22kW

Vehicle connection (output)	
1 x Charging plug Typ 2 with spiral cable	20 A* / 32 A, length about 4 m
Output voltage	230 / 400 V
Maximum charging current	16 A* / 32 A
Maximum charging power	11 kW* / 22 kW
Shutdown	All poles
Components	
DC fault current detection	electronic, I Δ n d.c. \geq 6mA
Load contactor	4-pole with contact monitoring
Protection class	IP54
Energy meter	Type PX EEM 357
Communication	
Interface	WLAN, LAN, Digital Input
Protocol	eCCP, OCCP 1.6J, Modbus TCP
Authorization	APP, RFID, Plug & Start
Management	APP statistics, Chargemanagementsystem (eLMS)
Requirement power connection	
Mains connection	5 x 4 mm ² * / 5 x 6 mm ²
Rated voltage	230 / 400 V
Rated current	16 A* / 32 A
Safeguarding	20 A* / 32 A, 3-poles, B-characteristics
AC fault current detection	RCCB, Type A, 30mA
Dimensions	
Height	970 mm
Diameter	114 mm
Parkbox (height / center)	750 mm

***) Technical data for a maximum charging power of 11 kW**

3 Installation

3.1 Demands on Location of Charging Stations Location



DANGER !

Safety note on a hazard with electrical voltage

Pay attention to a proper installation. Non-observance of the requirements leads to a danger with electric voltage.

The electrify eSat charging station is for outdoor and indoor use designed. For the installation of the loading unit, regulations regarding the location of installation must be ensured. Only in this way safe operation can be guaranteed.

The following requirements must be met:

- No installation in vulnerable areas with a high risk of flooding.
- No installation in vulnerable areas with a risk of explosion.
- Enough distance to other technical equipment.
- Select installation location so that the charging station can be reached easily with the parked vehicle (charging cable must not be strained during charging operation!).
- No direct spray water.
- Ambient temperature between -25 °C and 45 °C (-13°F and 113°F).
- For installation of low-voltage systems, the specifications IEC 60364-1 and IEC 60364-5-52 must be complied.
- In order to withstand mechanical stresses, the mounting surface must be designed with sufficient strength.
- Make sure that the power supply is sufficiently dimensioned. Note that the sizing does not exceed the slot of the cable routing of the socket. (Information on power connection: see technical data)





NOTE !

Important information and special features

Avoid a confusing installation location to prevent unnecessary damage to the charging station.

While selecting the location of the charging station, remember to avoid a possible knock down of the charging station. If necessary, set up a collision protection. Also avoid placement near entry and exit points. Set up the charging station so that the use of rescue vehicles is not restricted.

3.2 Creation of the Charging Stations Foundation

	<p>NOTE !</p> <p>Important information and special features</p> <p>For safe and stable mounting of the charging station, we recommend the Foundation Frame from hesotec electrify.</p>
	<p>DANGER !</p> <p>Safety note on a hazard with electrical voltage</p> <p>Make sure that the supply line is de-energized at the time of the creation of the foundation. Failure to observe the safety instructions can lead to a risk of death due to electrical voltage.</p>

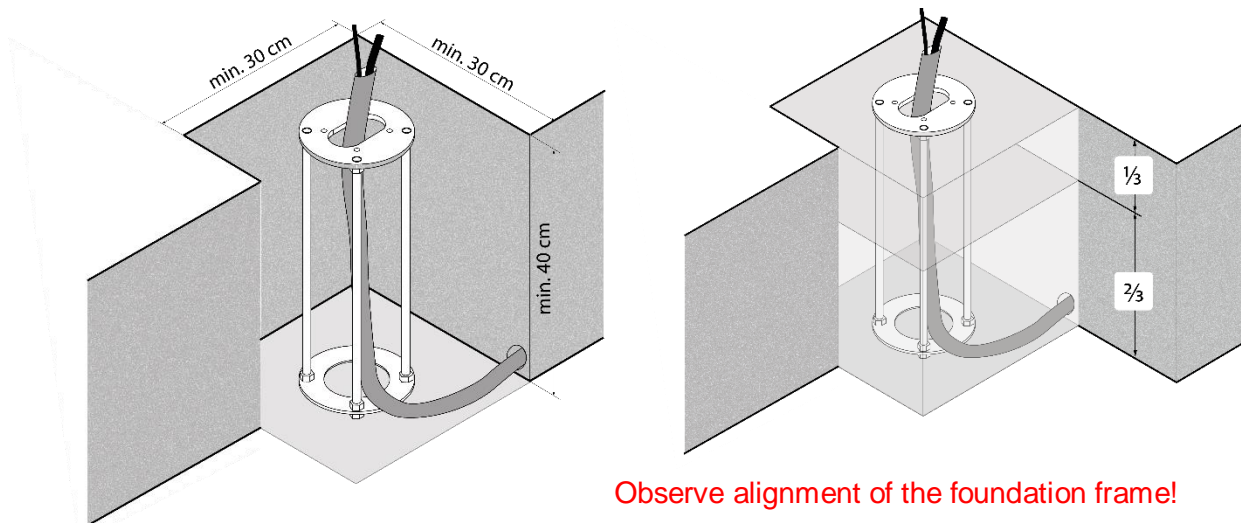

Observe alignment of the foundation frame!
See assembly instructions for foundation frame.

Foundation creation with foundation frame

After digging the soil, shutter the area of the foundation. Then insert the foundation frame and guide an empty conduit through the provided opening. To align the base frame, pay attention to the front mark, which is located on the mounting plate. Next you can lead the supply line through the empty conduit. Leave a sufficient length above the ground level. Level the foundation frame, making sure the foundation plate is flush with the ground level. Then fill the lower 2/3 of the foundation with class C30 / 25 concrete and let it set. The remaining 1/3 should be filled with shrink-free concrete, so that the foundation plate lies flush. After complete setting, the assembly takes place.

3.3 Assembly of Charging Station



DANGER !

Safety note on a hazard with electrical voltage

Make sure that the supply line is de-energized at the time of installation. Failure to observe the safety instructions can lead to a risk of death due to electrical voltage.

The electrify charging station eSat should only be installed by qualified personnel. Please refer to the respective subchapters for the respective assembly steps. **Make sure that the supply line is de-energized at the time of the assembly!**

3.3.1 Assembly with Montage with Foundation Frame

The electrify charging station eSat is already pre-assembled in the factory. To assemble the charging station, in combination with the foundation frame, proceed as follows:

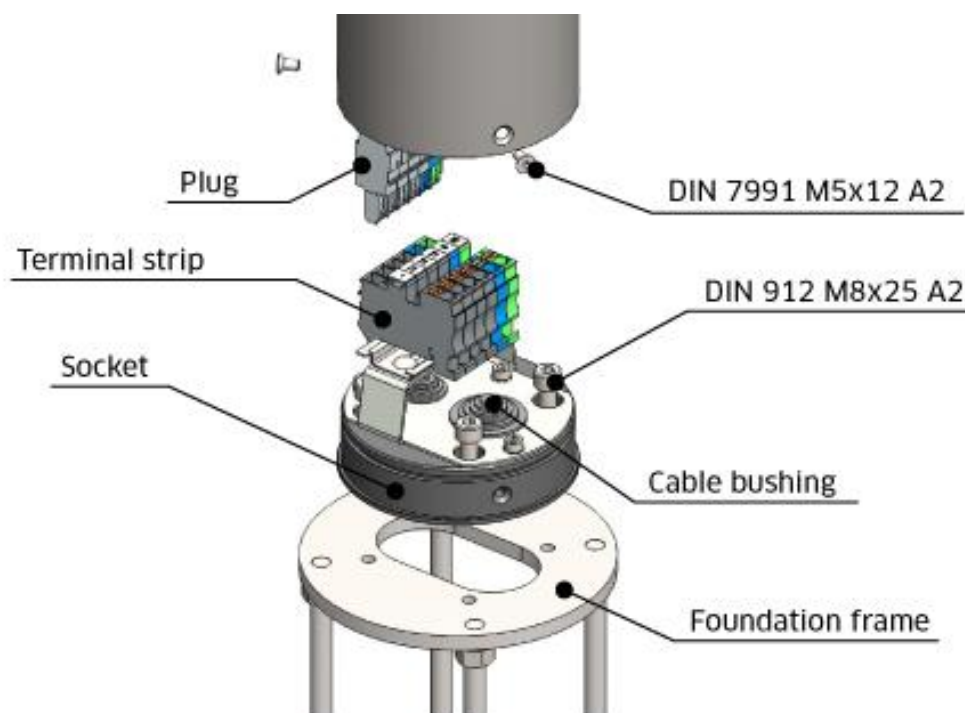

Installation in combination with foundation frame

1. First loosen the 3 side screws at the lower end of the charging station.
(similar to DIN 7991 M5x12 A2)
2. Then gently pull the black socket out of the charging station.

3. Feed the supply cable through the cable gland of the base and screw the base to the foundation frame, which has already been set in concrete, using the screws supplied. **(DIN 912 M8x25 A2)**
4. Before screwing the charging station to the base, read the chapter "**3.4.1 Electric installation of the Charging Station**".
5. After the successful electrical installation, place the charging post on the base and screw it with the 3 lateral screws. **(similar to DIN 7991 M5x12 A2)**

3.3.2 Assembly on an alternative Ground

The electrify charging station eSat is already preassembled in the factory. To install the charging station on an alternative ground, proceed as follows:

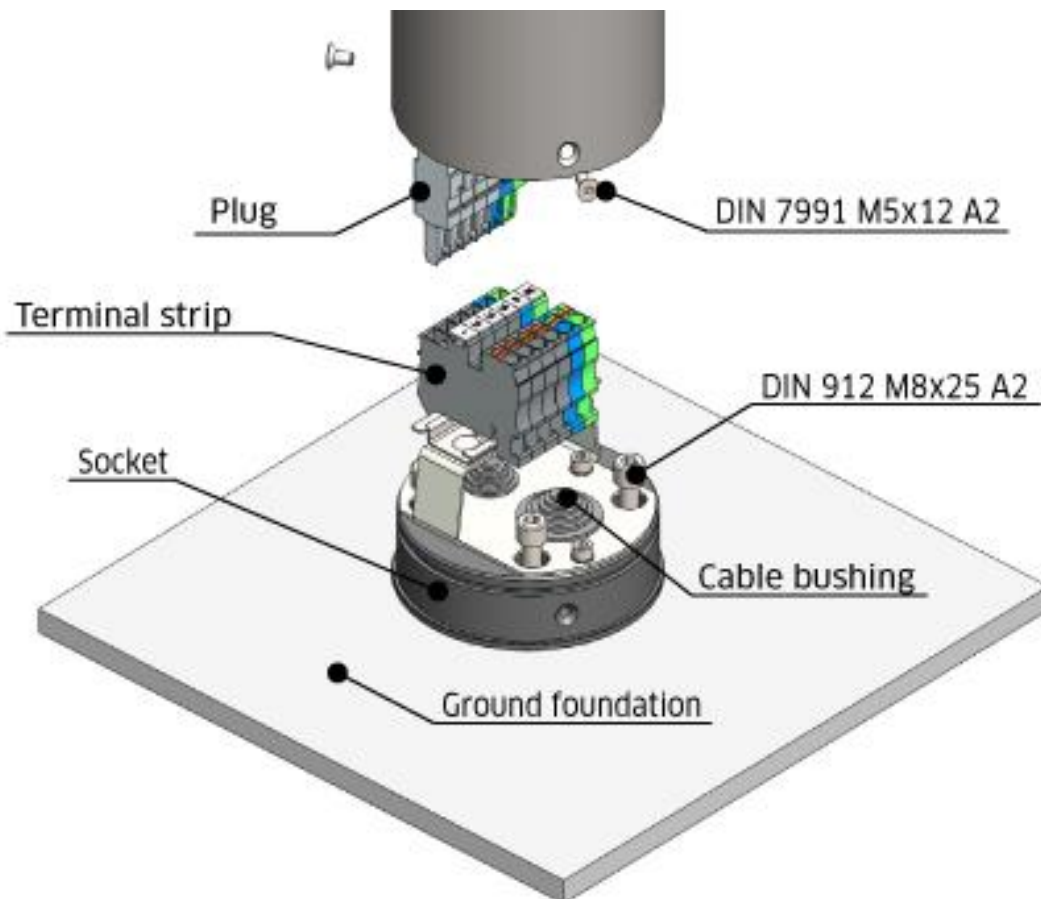

Installation on alternative ground



1. First loosen the 3 side screws at the lower end of the charging station. **(similar to DIN 7991 M5x12 A2)**
2. Then gently pull the black socket out of the charging station.
3. Place the base on the existing foundation and adjust it
4. Mark the mounting points of the base on the foundation.

5. Drill the previously marked holes (**∅ 10 mm**). Use the included mounting kit for mounting. Make sure that the fixing dowels are sunk into the foundation and do not protrude above.
6. Feed the supply cable through the cable gland of the base and screw the base with the screws provided. (**DIN 912 M8x25 A2**)
7. Before screwing the charging station to the base, read the chapter "**3.4.1 Electric installation of the Charging Station**".
8. After the successful electrical installation, place the charging post on the base and screw it with the 3 lateral screws. (**similar to DIN 7991 M5x12 A2**)

**ATTENTION !****Safety information on a hazard**

Make sure that the ground foundation has sufficient strength. Failure to follow the instructions may result in damage to the device itself or to other consumers.

3.4 Electrical Installation

	<p>DANGER !</p> <p>Safety note on a hazard with electrical voltage</p> <p>Make sure that the cables are de-energized at the time of installation. Failure to follow the instructions may result in a risk of death due to electrical voltage.</p>
	<p>ATTENTION !</p> <p>Safety information on a hazard</p> <p>Failure to follow the instructions may result in damage to the device itself or other consumers. Execution with special care!</p>

The electrical installation of the charging station may only be carried out by qualified personnel. When installing the electrical system, make sure that the cables are not damaged or crushed. These could interfere with the functions in later use, cause defects or even cause a fire.

The following table shows the connection diagram of the connection point between the ground side supply line and the charging unit cables including the functional description.

Supply Line Ground		Terminal Strip	Loading Unit	
Color	Function	Label	Color	Function
-	-	LR	black	Phase for power supply / charge controller
brown	Phase 1	L1	brown	Phase 1
black	Phase 2	L2	black	Phase 2
grey	Phase 3	L3	grey	Phase 3
blue	Neutral conductor	N	blue	Neutral conductor
green/yellow	Protective conductor	PE	green/yellow	Protective conductor

Connection diagram terminal strip electrify eSat r20

	<p>NOTE !</p> <p>Important information and special features</p> <p>Please take the requirements of the power connection from the technical data sheet in chapter 2.4.</p>
---	---

3.4.1 Electrical Installation of the Charging Station

The electrify eSat charging station is already preassembled in the factory and wired electronically. All you have to do is connect the supply line to the connection socket.

For the electrical installation of the charging station, proceed as follows:

1. Connect the 5-wire cable coming from the ground to the terminal strip according to the terminal label. **(L1, L2, L3, N, PE)**
2. Insert the plug coming in from the charging station into the terminal strip.

Note: Depending on the equipment, the LAN connection (item 1) is in the Charging column (see data sheet in chapter 2.4.). Digital inputs (item 2).

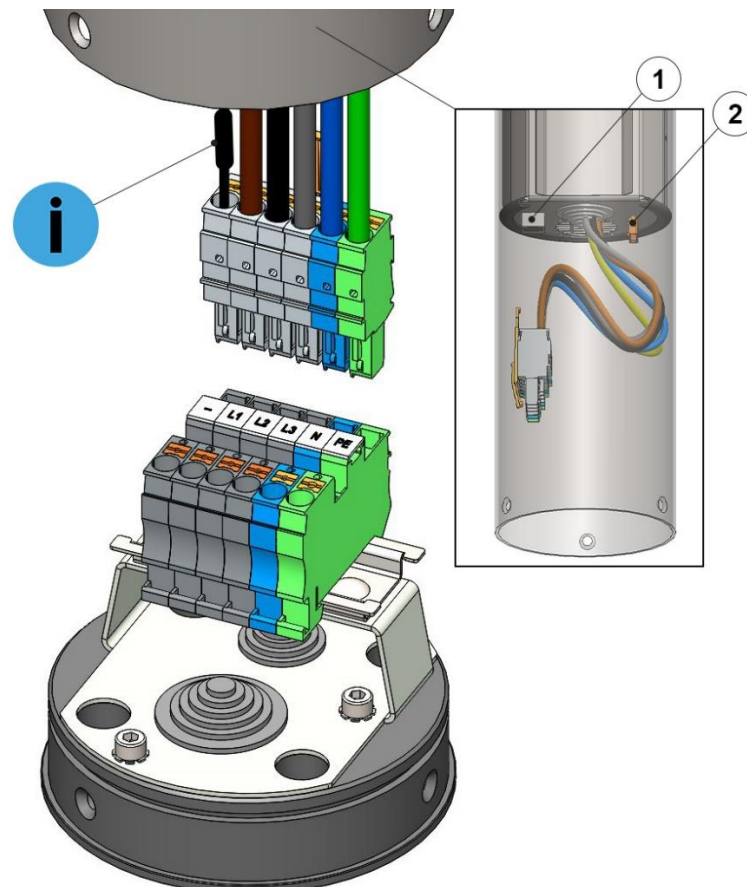

Wiring the electrify eSat charging station

NOTE !

Important information and special features

The cable LR of the 22kW version is provided with a fuse (G-fuse link 5X20mm 10A).



3.4.2 Connection of the digital inputs

The electrify eSat charging unit is equipped with an interface for digital inputs. With the digital inputs, you have the option of reducing the charging power to 75%, 50%, 25% or switching the charging station to the break mode. The wiring of the individual inputs is shown in the graphic below.

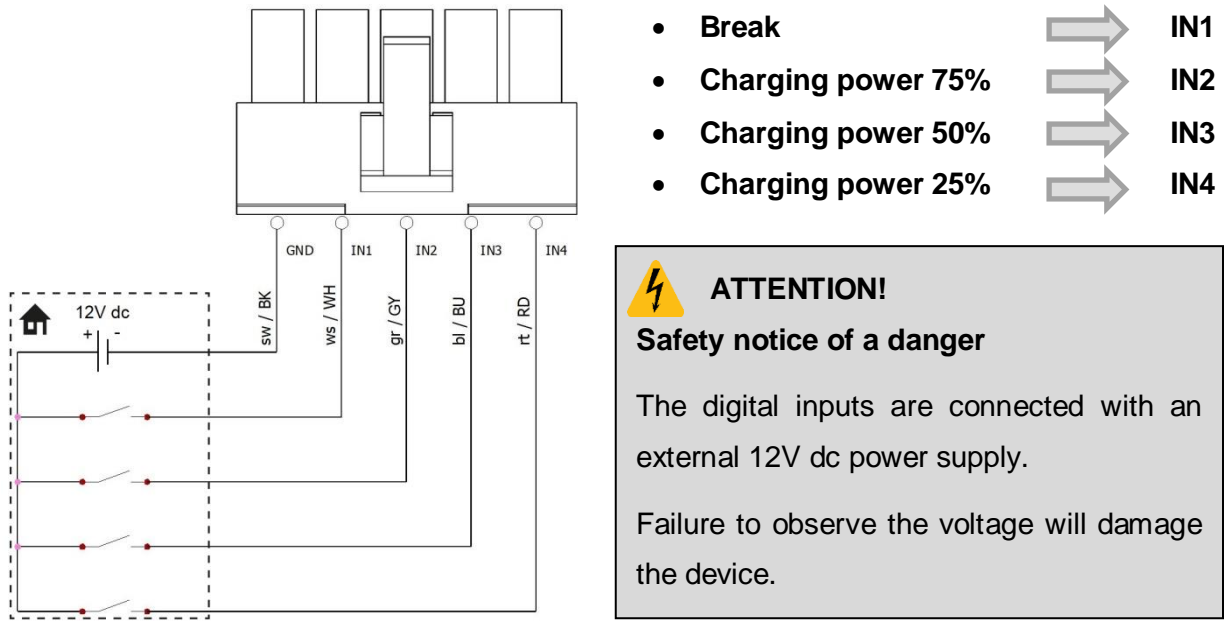

Connection drawing of the digital inputs

To use the digital inputs, use the cable adapter included in the scope of delivery. The installation location is shown in the following illustration.

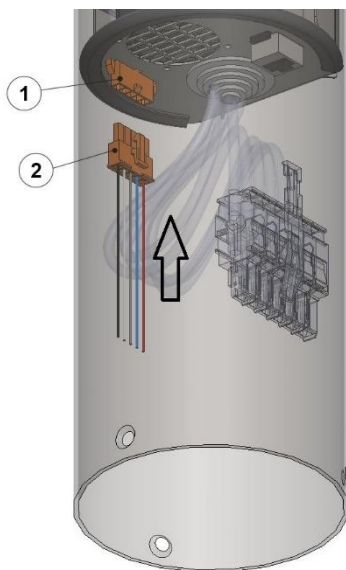

1. Connector for digital input
2. Cable adapter for digital input

⚠ ATTENTION!
Safety notice of a hazard

The electrical installation of the digital inputs may only be carried out by qualified specialist personnel.

Plug connection of the digital inputs

4 Operation

Your electrify charging station is delivered preconfigured at the factory. With the help of the electrify Charge Control App (eCC) or the electrify Charge Management System (eLMS) you can make further settings and evaluations.

4.1 Control Element

The following graphic shows the main operating elements of the electrify eSat r20 charging station:

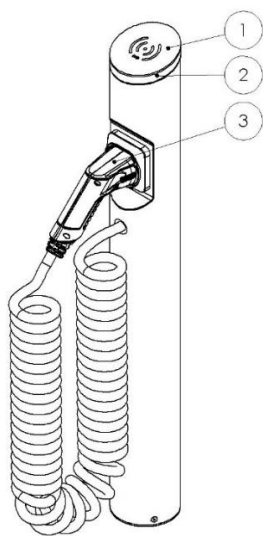

1. RFID – Card Reader
2. LED indicator
3. Charging Cable

Operating elements of the electrify Charging Station eSat

4.2 LED indicator

The electrify eSat signals the respective operating status with the aid of the LED indicator. With the **electrify charge control app**, the user can choose between 8 colours.



Green



Blue



White



Red



Yellow



Orange







Pink



Purple

The electrify eSat charging station is preconfigured with a color combination to indicate the operating status. The default color scheme, with the associated operating status, is shown in the following table:

Graphic	Operating Status
 <p data-bbox="272 696 355 725">Green</p>	<p data-bbox="469 477 1102 510">State A: Charging Station is ready for operation.</p>
 <p data-bbox="284 981 346 1010">Blue</p>	<p data-bbox="469 761 967 795">State B: Electric vehicle is plugged in.</p> <p data-bbox="469 826 976 860">State C: Charging is active (pulsating).</p>
 <p data-bbox="277 1265 355 1294">White</p>	<p data-bbox="469 1046 1035 1079">Wait for authorization via app or RFID card.</p>
 <p data-bbox="288 1550 344 1579">Red</p>	<p data-bbox="469 1330 1086 1364">State E: There is a fault at the charging station.</p>



NOTE !

Important information and special features



The color scheme is configured with the electrify Charge Control app. Not only the color but also the dynamics can be adjusted. (Light permanent or pulsating)

For more information, see the Quick Guide of the electrify app.

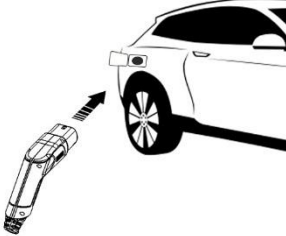

4.3 Charging Process

The charging process of the electrify charging stations is the same for all product variants. No matter if you decide for the base, smart or other. Only the approval of the charging process is different among each other.



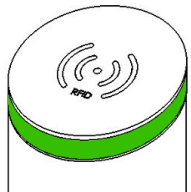
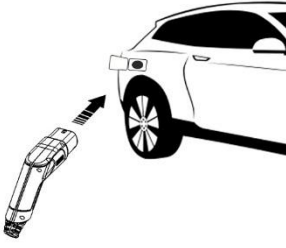
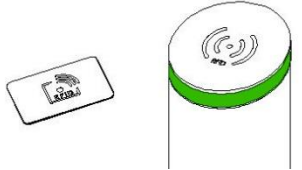

4.3.1 Charging station without authorization (Plug & Start)

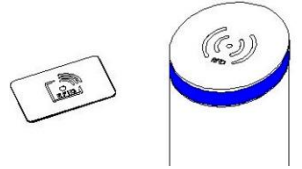
Process Step	Information	Graphic
1. First check the operating status of the eSat charging station.	eSat charging station is ready for operation with green LED indicator.	
2. Connect the charging plug to the vehicle to be charged.	After the charging plug is successfully connected to the vehicle, the locking takes place. Further information can be found in the operating instructions of the vehicle.	
3. Charging is started.	After a successful authorization, the loading process is released. The LED indicator lights up blue.	
4. End charging process prematurely.	The charging process can be stopped via the vehicle. The latter is taken from the operating instructions of the vehicle	

4.3.2 Charging station with RFID authorization

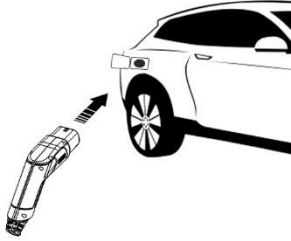
Process Step	Information	Graphic
<p>1. First check the operating status of the eSat charging station.</p>	<p>eSat charging station is ready for operation with green LED indicator.</p>	
<p>2. Connect the charging plug to the vehicle to be charged.</p>	<p>After the charging plug is successfully connected to the vehicle, the locking takes place. Further information can be found in the operating instructions of the vehicle.</p>	
<p>3. Authorization by appropriate RFID card.</p>	<p>Place the appropriate RFID card on top of the RFID card reader.</p>	
<p>4. Charging is started.</p>	<p>After a successful authorization, the loading process is released. The LED indicator lights up blue.</p>	
<p>5. End charging process prematurely.</p>	<p>The charging process can be ended by placing the RFID card on the reader or via the vehicle. The latter can be found in the operating instructions of the vehicle.</p>	

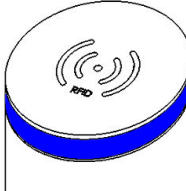
4.3.3 Charging Station with App Authorization (electrify Control Center)

Process Step	Information	Graphic
<p>1. First check the operating status of the eSat charging station.</p>	<p>eSat charging station is ready for operation with green LED indicator.</p>	
<p>2. Connect the charging plug to the vehicle to be charged.</p>	<p>After the charging plug is successfully connected to the vehicle, the locking takes place. Further information can be found in the operating instructions of the vehicle.</p>	
<p>3. Authorization by app with WLAN connection.</p>	<p>Connect the mobile phone to the Wifi and authorize the charging process via app.</p>	
<p>4. Charging is started.</p>	<p>After a successful authorization, the loading process is released. The LED indicator lights up blue.</p>	
<p>5. End charging process prematurely.</p>	<p>The charging process can be ended with the app or via the vehicle. The latter can be found in the operating instructions of the vehicle.</p>	

5 Troubleshooting

With the purchase of your eSat charging station, you have chosen a robust and compact design with maximum safety in operation and reliable charging for your electric and hybrid vehicle. With intelligent control, the eSat detects a fault and stops the operation immediately. Should a malfunction occur in the application, you will be informed via the LED indicator. In the following chapters, you will learn which troubleshooting procedures can be performed.

5.1 Troubleshooting

In this chapter, you will learn which actions you, as the user of the eSat charging station, can carry out independently.

Disorder	Possible Cause	Troubleshooting
The LED indicator of the eSat charging station does not light up.	The Residual Current Device (R.C.D.) has tripped.	Check in the subdivision of the house, if all fuses are switched on.
The charging process can not be started.	<ul style="list-style-type: none">• The charging cable is not properly connected to the vehicle or to the charging station.• Charging is not permitted by the vehicle.	<ul style="list-style-type: none">• Check the plug connection on the vehicle or at the charging station.• Start charging via the vehicle (see vehicle operating manual).
The charging plug can not be disconnected from the charging station.	The unlocking of the locking mechanism does not work.	<ul style="list-style-type: none">• Place the RFID card again on the card reader.• Try to finish the charging process on the vehicle.• Disconnect the power of the charging station.

5.2 Repair work



DANGER !

Safety note on a hazard with electrical voltage

Make sure that the cables are de-energized at the time of repair. Non-observance of the safety instructions can lead to a risk of mortal danger due to electrical voltage.

Repairs to the charging station may only be carried out by a qualified specialist. It should be noted that only spare parts released by hesotec electrify are permissible. If necessary, contact the manufacturer.

6 Maintenance / Disposal



DANGER !

Safety note on a hazard with electrical voltage

Make sure that the cables are de-energized at the time of maintenance. Non-observance of the safety instructions can lead to a risk of mortal danger due to electrical voltage.

The eSat charging stations from hesotec electrify are designed so that they are generally maintenance-free. Nevertheless, visual inspections should be carried out at regular intervals.

6.1 Maintenance

Hesotec electrify recommends carrying out a test at intervals of 6 months.

- **Charging Station**
 - Check the charging station for visual damage and defects.
 - Check the functionality of the charging socket.
 - Check if the charging cable is damaged.
 - Check the stability of the column on the foundation.

6.2 Disposal

Old electronic devices must be disposed according to the current guidelines and disposal regulations of the respective location. Disposal with household waste is strictly prohibited! Only uses a collection point intended for electronic waste or dispose it through a specialist retailer.

The disposal of the packaging material can take place via collection points for paper and plastics.

7 Appendix

7.1 CE-Label and Declaration of Conformity

The electrify eSat charging station of hesotec electrify is marked with a CE label. A copy of the Declaration of Conformity will be presented later. On request, this is available from hesotec electrify gmbh.

ZERTIFIKAT / CERTIFICATE



CE - KONFORMITÄTSERKLÄRUNG CE - DECLARATION OF CONFORMITY

Hersteller manufacturer	hesotec gmbh Rubbetskath 34 46539 Dinslaken / Germany
Produkt Product	Ladesäule electrify eSat Charger electrify eSat
Typennummer reference number	r10 / r20 r10 / r20
Die Forderungen folgender europäischer Richtlinien werden erfüllt In conformity with the following european directives	Niederspannungsrichtlinie 2014 / 35 / EU EMV Richtlinie 2014 / 30 / EG Low Voltage Directive 2014 / 35 / EU EMC Directive 2014 / 30 / EC
Angewendete Normen (harmonisiert) applied standards (harmonized)	DIN EN 61851:2012 IEC 61851-22 ed. 2.0 (69 / 201 / CD) EN 55011 EN 61000-6- 2 / 3 - EN 61000-3-11 - EN 61000-3-12 EN 61000-4-11 DIN IEC / TS 61439-7:2014 VDE-AR-N 4102: 04-2012
Jahr der CE-Kennzeichnung year of declaration	2019 2019

hesotec gmbh
Rubbetskath 34
46539 Dinslaken / Germany

Tel. +49 (0) 60105-60
Fax. +49 (0) 60105-50
electrify@hesotec.de

15.08.2019

Datum
Date

Unterschrift
signatur

Sebastian Hellmich
Sebastian Hellmich

- Geschäftsführer -
- managing director -

Diese Erklärung bescheinigt die Übereinstimmung mit den oben genannten Richtlinien und beinhaltet keine Zusicherung von Eigenschaften. This declaration certifies the conformity to the specified directives but contains no assurance of properties.

8 Notes

hesotec electrify gmbh

Rubbetskath 34

46539 Dinslaken / GER

Phone +49(0) 2064 / 60 105 – 60

Fax +49(0) 2064 / 60 105 - 50

Mail electrify@hesotec.de

Web electrify.hesotec.de

hesotec
electrify